

Verschraubungen passend zu / cable-glands suitable for HFX-V0, ZHUA, ZHLS, Z1 Shieldtite®/Sealtite®
Schutzschläuchen / protection conduits

Material Gehäuse, Überwurfmutter / material body, counter nut: Messing vernickelt / nickelplated

Material Einschraubhülse / material ferrule: Stahl verzinkt / galvanised steel

Material Klemmring / material clamping ring: PA6 / PA6

Material O-Ring / material O-ring: NBR Gummi / NBR rubber

Schutzart / protection grade: IP 66 / 67, NEMA 4X

Temperaturbereich / temperature range: -45°C - +105 °C

Farbe / color: Metall / metal

Spezielle Prüfzeichen / specifics:

- UL-514B und CSA 22.2 (Kombination UL/CSA file # E 234207). Die Anwendung ist geeignet für gefährliche Umgebungen nach der NEC; Article 501.10 (B) (2) Class I, Division 2, Article 502.10 (A) (2) und (B) (2) Class II, Division 1 und 2. Article 503.10 (A) (3) und (B) Class III, Division 1 und 2. Die Abmessungen 5/16" Schläuche haben keine UL/CSA Zulassung. Die Kabel-Schlauch-Verschraubungen sind ausgerüstet m. d. Dichtungsgummi aus flammhemmenden V0-freigegebenen EPDM Material nach HL 1, HL 2 und HL 3 laut der EN 45545-2, R22 u. R 23.

/UL-514B and CSA C 22.2 (combined UL/CSA (CUL) file # E 234207). Suitable for use in hazardous environments according to NEC:- Article 501.10 (B) (2) Class I, Division 2- Article 502.10 (A) (2) and (B) (2) Class II, Division 1 and 2- Article 503.10 (A) (3) and (B) Class III, Division 1 and 2 Note *: Sizes 1/4", 5/16", 2.1/2" and 3" do not have UL/CSA approval. The cable-hose fittings have clamping rubbers from flame retardant V0-rated EPDM and are HL 1, HL 2 and HL 3 according EN 45545-2, R22 and R23



GOGACON Compact Verschraubung, Messing vernickelt /
cable gland compact, brass nickel-plated

Gew inde ISO thread	Schlauch NW Zoll conduit size	Min. Innen Ø mm min. inner Ø	Abmessungen mm A B C D E dimensions					VPE Gewicht PU weight	Artikel Nr. part no.	€/Stk. /pc.	
			A	B	C	D	E				
M20 x 1,5	5/16"	8,3	30	10	26	-	24	10	0,045	79-712.014.0	7,38
M16 x 1,5	5/16"	8,3	30	10	26	-	24	10	0,044	79-712.015.0	6,90
M16 x 1,5	3/8"	11	31	10	26	-	24	10	0,039	79-712.016.1	5,19
M20 x 1,5	3/8"	11	31	10	26	-	24	10	0,04	79-712.017.1	5,65
M20 x 1,5	1/2"	14,5	32	10	29	-	27	10	0,044	79-712.020.1	5,98
M25 x 1,5	3/4"	19,4	33	10	35	-	33	5	0,066	79-712.025.1	9,24
M32 x 1,5	1"	24,7	36	12	45	-	42	5	0,117	79-712.032.1	14,73
M40 x 1,5	1.1/4"	33,3	40	13	53	-	50	2	0,16	79-712.040.1	23,72
M50 x 1,5	1.1/2"	38	46	14	62	-	58	2	0,253	79-712.050.1	33,29
M63 x 1,5	2"	49	52	16	76	-	72	2	0,386	79-712.063.1	47,69

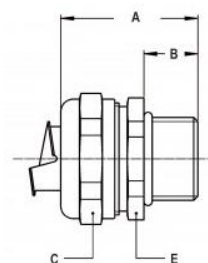

GOGACON 90° Compact Verschraubung, Messing vernickelt /
cable gland 90° compact, brass nickel-plated

ISO thread	Zoll conduit size	mm min. inner Ø	A	B	C	D	E	kg PU weight	part no.	/pc.	
M16 x 1,5	5/16"	8,3	26	10	26	31	22	10	0,066	79-712.915.0	a.A.
M20 x 1,5	5/16"	8,3	26	10	26	32	24	10	0,079	79-712.914.0	a.A.
M16 x 1,5	3/8"	11,0	26	10	26	31	22	10	0,066	79-712.916.1	9,30
M20 x 1,5	3/8"	11,0	26	10	26	32	24	10	0,079	79-712.917.1	10,94
M20 x 1,5	1/2"	14,5	28	10	29	34	27	10	0,092	79-712.920.1	11,08
M25 x 1,5	3/4"	19,4	32	10	35	40	33	5	0,162	79-712.925.1	17,52
M32 x 1,5	1"	24,7	40	12	45	49	42	5	0,278	79-712.932.1	31,85
M40 x 1,5	1.1/4"	33,3	46	13	53	53	52	2	0,401	79-712.940.1	51,20
M50 x 1,5	1.1/2"	38,0	52	14	62	57	60	2	0,575	79-712.950.1	68,90
M63 x 1,5	2"	62	62	16	76	68	72	2	0,906	79-712.963.1	103,40

a. A. = auf Anfrage / upon request

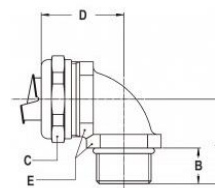

Preise gültig ab 01.07.2022 exkl. MwSt., freibleibend, Auftragsrabatt auf Anfrage /

prices are valid from 01.07.2022 excl. VAT, subject to change, discounts upon request

sonst. Konditionen siehe www.gogatec.com/AGB.pdf, techn. Änderungen vorbehalten /

terms & conditions can be found on our website: www.gogatec.com/AGB.pdf; error, technical modifications and variations are reserved

GOGACON 45° Compact Verschraubung, Messing vernickelt /
cable gland 45° compact, brass nickel-plated

Gew inde ISO thread	Schlauch NW Zoll conduit size	Min. Innen Ø mm min. inner Ø	Abmessungen mm A B C D E dimensions					VPE PU	Gew icht kg weight	Artikel Nr. part no.	€/Stk. /pc.
			A	B	C	D	E				
M16 x 1,5	5/16"	8,3	19	10	26	27	22	10	0,063	79-712.415.0	a.A.
M20 x 1,5	5/16"	8,3	20	10	26	28	24	10	0,072	79-712.414.0	a.A.
M16 x 1,5	3/8"	11	19	10	26	27	22	10	0,063	79-712.416.1	9,30
M20 x 1,5	3/8"	11	20	10	26	28	24	10	0,072	79-712.417.1	a.A.
M20 x 1,5	1/2"	14,5	21	10	29	30	27	10	0,083	79-712.420.1	11,08
M25 x 1,5	3/4"	19,4	23	10	35	33	33	5	0,128	79-712.425.1	17,52
M32 x 1,5	1"	24,7	28	12	45	38	42	5	0,225	79-712.432.1	31,85
M40 x 1,5	1.1/4"	33,3	33	13	53	39	52	2	0,345	79-712.440.1	a.A.
M50 x 1,5	1.1/2"	38	35	14	62	46	60	2	0,500	79-712.450.1	68,90
M63 x 1,5	2"	49	40	16	76	53	72	2	0,805	79-712.463.1	a.A.

a. A. = auf Anfrage / upon request

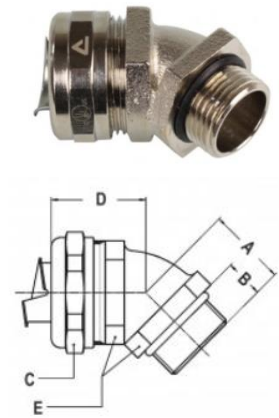

GOGACON Kabel-Schlauch Verschraubung, Compact, /
cable-hose fitting, compact, nickel plated brass

Temperaturbereich / temperature range : -40°C - +100 °C

Gew inde ISO thread	Schlauch NW Zoll conduit size	Klemm-bereich mm clamping range	Abmessungen mm A B C E F dimensions						VPE PU	Gew icht kg weight	Artikel Nr. part no.	€/Stk. /pc.
			A	B	C	E	F					
M12 x 1,5	1/4"	1,0 - 5,2	46	9	19	17	14	10	0,040	79-712.712.2	a.A.	
M16 x 1,5	1/4"	1,0 - 5,2	47	10	19	17	18	10	0,047	79-712.713.2	a.A.	
M16 x 1,5	5/16"	4,0 - 8,3	50	10	22	20	18	10	0,057	79-712.715.2	a.A.	
M20 x 1,5	5/16"	4,0 - 8,3	50	10	22	20	22	10	0,064	79-712.714.2	19,10	
M16 x 1,5	3/8"	4,0 - 9,5	50	10	26	24	18	10	0,068	79-712.716.1	a.A.	
M20 x 1,5	3/8"	4,0 - 9,5	50	10	26	24	22	10	0,074	79-712.717.1	17,86	
M20 x 1,5	1/2"	6,0 - 13,0	53	10	29	27	22	10	0,076	79-712.720.1	18,20	
M25 x 1,5	1/2"	6,0 - 13,0	54	10	29	27	27	5	0,090	79-712.722.1	21,63	
M25 x 1,5	3/4"	10,0 - 18,0	56	10	35	33	27	5	0,117	79-712.725.1	27,39	
M32 x 1,5	3/4"	10,0 - 18,0	58	12	35	33	35	5	0,150	79-712.728.1	a.A.	
M32 x 1,5	1"	16,0 - 25,0	61	12	45	42	35	5	0,203	79-712.732.1	46,80	
M40 x 1,5	1"	16,0 - 25,0	63	13	45	42	43	2	0,245	79-712.735.1	56,30	
M40 x 1,5	1.1/4"	22,0 - 32,0	69	13	53	50	43	2	0,286	79-712.740.1	65,20	

a. A. = auf Anfrage / upon request

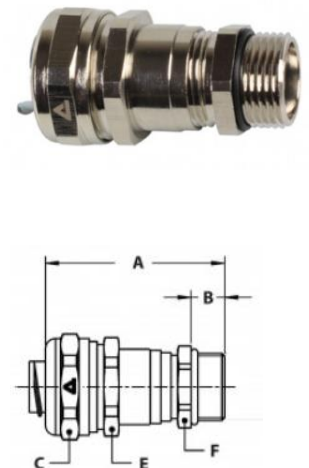

GOGACON drehbare Verschraubung, Messing vernickelt /
swivel fitting, nickel plated brass

Gew inde ISO thread	Schlauch NW Zoll conduit size	Min. Innen Ø mm min. inner Ø	Abmessungen mm A B C D E dimensions					VPE PU	Gew icht kg weight	Artikel Nr. part no.	€/Stk. /pc.
			A	B	C	D	E				
M16 x 1,5	5/16"	8,3	48	10	26	24	21	10	0,081	79-813.015.0	13,26
M16 x 1,5	3/8"	10,4	48	10	26	24	21	10	0,081	79-813.016.0	12,14
M20 x 1,5	1/2"	13,8	49	10	29	27	25	10	0,102	79-813.020.0	13,78
M25 x 1,5	3/4"	17,4	49	10	35	33	31	5	0,138	79-813.025.0	18,13
M32 x 1,5	1"	23,4	55	12	45	42	38	5	0,325	79-813.032.0	30,15
M40 x 1,5	1.1/4"	29,4	58	14	54	50	48	2	0,530	79-813.040.0	39,02
M50 x 1,5	1.1/2"	36,9	65	14	62	58	55	2	0,740	79-813.050.0	61,40
M63 x 1,5	2"	47,9	74	16	76	72	68	2	1,300	79-813.063.0	91,40

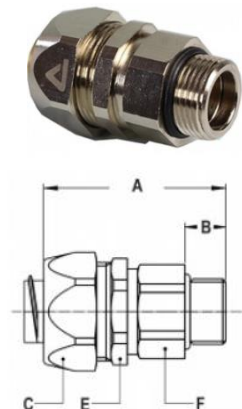

Preise gültig ab 01.07.2022 exkl. MwSt., freibleibend, Auftragsrabatt auf Anfrage /

prices are valid from 01.07.2022 excl. VAT, subject to change, discounts upon request

sonst. Konditionen siehe www.gogatec.com/AGB.pdf, techn. Änderungen vorbehalten /

terms & conditions can be found on our website: www.gogatec.com/AGB.pdf; error, technical modifications and variations are reserved

GOGACON 90° drehbare Winkel-Verschraubung, Messing vernickelt /
90° swivel fitting, nickel plated brass

Gew inde ISO thread	Schlauch NW Zoll conduit size	Min. Innen Ø mm min. inner Ø	Abmessungen mm dimensions						VPE PU	Gew icht kg weight	Artikel Nr. part no.	€ /Stk. /pc.
			A	B	C	D	E	F				
M16 x 1,5	5/16"	8,3	39	10	26	35	22	22	10	0,108	79-813.915.0 a.A.	
M16 x 1,5	3/8"	10,4	39	10	26	35	22	22	10	0,108	79-813.916.0 a.A.	
M20 x 1,5	1/2"	13,8	39	10	29	37	27	25	10	0,132	79-813.920.0 27,56	
M25 x 1,5	3/4"	17,4	46	10	35	44	33	31	5	0,228	79-813.925.0 44,25	
M32 x 1,5	1"	23,4	55	12	45	55	42	38	5	0,414	79-813.932.0 a.A.	

a. A. = auf Anfrage / upon request

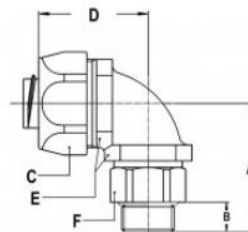

GOGACON 45° drehbare Winkel-Verschraubung, Messing vernickelt /
45° swivel fitting, nickel plated brass

Gew inde ISO thread	Schlauch NW Zoll conduit size	Min. Innen Ø mm min. inner Ø	Abmessungen mm dimensions						VPE PU	Gew icht kg weight	Artikel Nr. part no.	€ /Stk. /pc.
			A	B	C	D	E	F				
M16 x 1,5	3/8"	10,4	34	10	26	28	22	21	10	0,095	79-813.416.0 a.A.	
M20 x 1,5	1/2"	13,8	34	10	29	30	27	25	10	0,135	79-813.420.0 a.A.	
M25 x 1,5	3/4"	17,4	37	10	35	32	33	31	5	0,215	79-813.425.0 a.A.	
M32 x 1,5	1"	23,4	41	12	45	37	42	38	5	0,365	79-813.432.0 a.A.	

a. A. = auf Anfrage / upon request

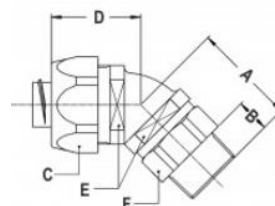

GOGACON EMV Kabel-Schlauch-Verschraubung, Messing vernickelt /
EMC cable-hose fitting, nickel plated brass

Temperaturbereich / temperature range : -40°C - +100 °C

Gew inde ISO thread	Schlauch NW Zoll conduit size	Min. Innen Ø mm min. inner Ø	Abmessungen mm dimensions						VPE PU	Gew icht kg weight	Artikel Nr. part no.	€ /Stk. /pc.
			A	B	C	E	F					
M16 x 1,5	5/16"	4 - 8	57	12	26	24	18	10	0,052	79-812.615.2	29,73	
M16 x 1,5	3/8"	4 - 8	57	12	26	24	18	10	0,078	79-812.616.1	29,73	
M20 x 1,5	3/8"	6 - 10,2	57	12	26	24	22	10	0,095	79-812.617.1	29,73	
M20 x 1,5	1/2"	6 - 12	59	12	29	27	22	10	0,097	79-812.620.1	34,49	
M25 x 1,5	1/2"	10 - 13,9	62	12	29	27	27	5	0,117	79-812.622.1	43,86	
M32 x 1,5	3/4"	13 - 18	70	15	35	33	34	5	0,196	79-812.628.1	62,20	
M40 x 1,5	1"	18 - 23,8	83	15	45	43	43	2	0,354	79-812.635.1	96,60	

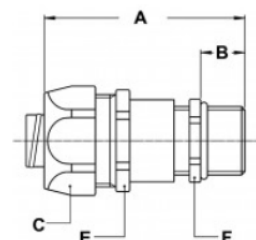

Preise gültig ab 01.07.2022 exkl. MwSt., freibleibend, Auftragsrabatt auf Anfrage /

prices are valid from 01.07.2022 excl. VAT, subject to change, discounts upon request

sonst. Konditionen siehe www.gogatec.com/AGB.pdf, techn. Änderungen vorbehalten /

terms & conditions can be found on our website: www.gogatec.com/AGB.pdf; error, technical modifications and variations are reserved